

HOME SECURITY HARDWARE

LOK-SAFE

THE PATENTED SECURITY LOCK FOR SLIDING PATIO DOORS.

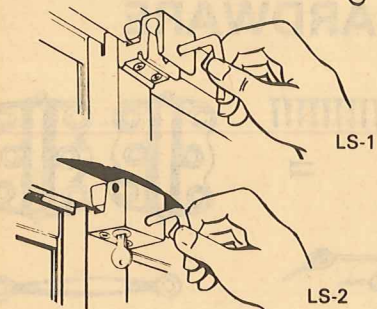

Simple 5 minute installation. One lock will secure up to two moving doors. LOK-SAFE forms a burglar-proof bond between door and frame that resists forced entry.

- L5-60A Aluminum Patio Lock 3.99
- L5-50A Key Patio Lock 5.99

WEATHERSTRIP

W. J. DENNIS CO.

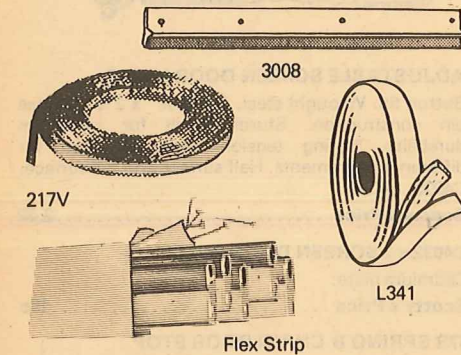

- 19 AIR CONDITIONER WEATHERSTRIP**
1 1/4" x 1 1/4" x 42".
Scotty's Price 75c
- 202 FOAM WEATHERSTRIP**
White all-purpose, self-adhesive. 3/16" x 17' roll.
Scotty's Price 85c
- ST2 17' VINYL WEATHERSTRIP**
Scotty's Price 1.19
- 217V ALUMINUM VINYL WEATHERSTRIP**
White metal and tubular vinyl weatherstrip. 5/8" x 17' roll does one average window or door. Serrated, pre-punched with nails included.
Scotty's Price 1.59
- BIS 17' SPONGE WEATHERSTRIP**
Scotty's Price 2.69
- FLEX STRIP WEATHERSTRIP**
One set for 3' x 7' door.
Scotty's Price 1.98
- PV3031 VINYL WEATHERSTRIPPING SET**
Scotty's Price 2.19
- PV3055 ALUMINUM WEATHERSTRIP SET**
Scotty's Price 2.45
- 3008 36" ALUMINUM BUG SWEEP**
Has neoprene strip. Keep bugs out.
Scotty's Price 79c
- V-432 36" VINYL BUG SWEEP**
Scotty's Price 65c

CAMPBELL CHAIN

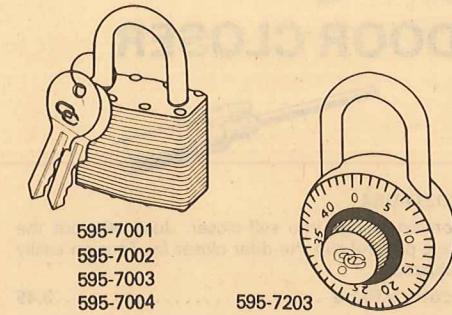

- LAMINATED PIN TUMBLER PADLOCKS** have a 4-pin tumbler-cylinder and pick resistant brass mushroom shaped pins. Extra strong countersunk riveting.
- 595-7001 1 1/4" 1.86
 - 595-7002 1 1/2" 2.59
 - 595-7003 1 3/4" 2.99
 - 595-7004 2" 3.79
- SECURITY DIAL COMBINATION PADLOCK** has heavy steel inner case, stainless steel outer case, 3-position locking mechanism, built-in anti-manipulation feature to prevent picking. Has dial scrambler to assure security.
- 595-7203 1 3/4" Combination Padlock 2.10

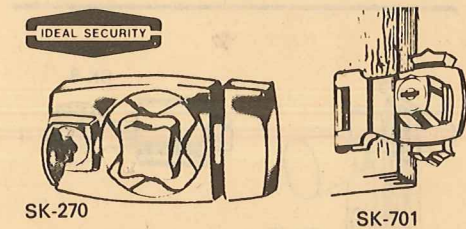

- SK-701AP KEYED MINI-HASP**
Scotty's Price 4.95
- SK-270AP KEY DEAD LATCH**
Scotty's Price 6.25

THRESHOLDS

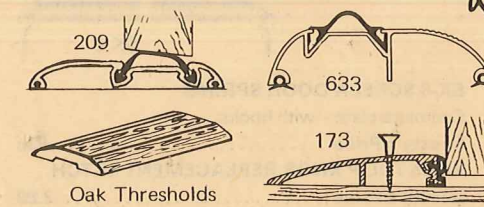

- 37" OAK THRESHOLD** 1.39
- V4 36 1/2" VINYL THRESHOLD INSERT** 39c
- 173, 209 ALUMINUM THRESHOLDS**
Have vinyl strip, no upkeep, won't rust or wear. Specified by contractors and do-it-yourselfers for homes and apartments.
- 173 36" 1.99
- 173 72" 4.19
- 209 36" 2.29

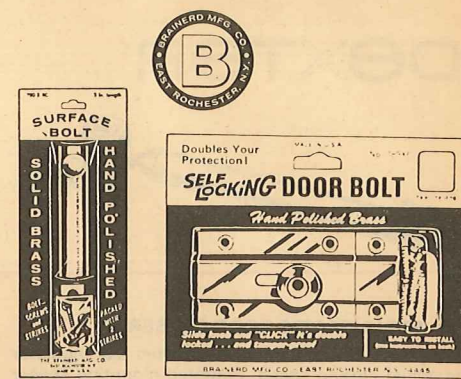

- 789XC "SELF LOCKING" DOOR BOLT** provides positive locking. Pick-proof from outside. Brass. Screws included.
- Scotty's Price 2.69
- 790-3XC 3" BRASS SURFACE BOLT**
Scotty's Price 2.69

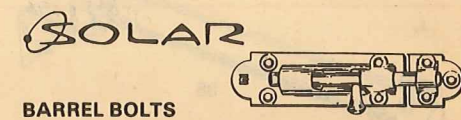

- BARREL BOLTS**
A multi-purpose latch that can be used on cupboards, closets and all types of doors. Makes a handy, inexpensive night latch. C3200.
- 2 1/2" 44c
 - 3" 47c

- CHAIN DOOR GUARD**
Easy installation instructions on package. Available in aluminum and brass. Install in 2 easy steps.
- Scotty's Price 83c

- BURGLAR-PROOF HINGE GUARD™**
FOR OUTSWINGING DOORS
- Aluminum 1.44
 - Gold Colored 1.44

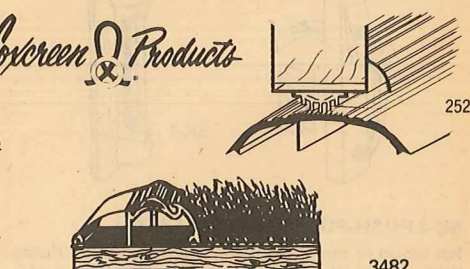

- 633 HI-RUG ALUMINUM THRESHOLD**
Has vinyl strip. For use in carpeted areas.
- 633 36" 2.99
- 252 SADDLE COMBINATION THRESHOLD**
Two-piece unit for use with 1 3/4" door.
- 252 36" 4.15
- 3482 HI-RUG THRESHOLD**
Extra high model for use with thick shag carpets.
- 3482 36" 3.79

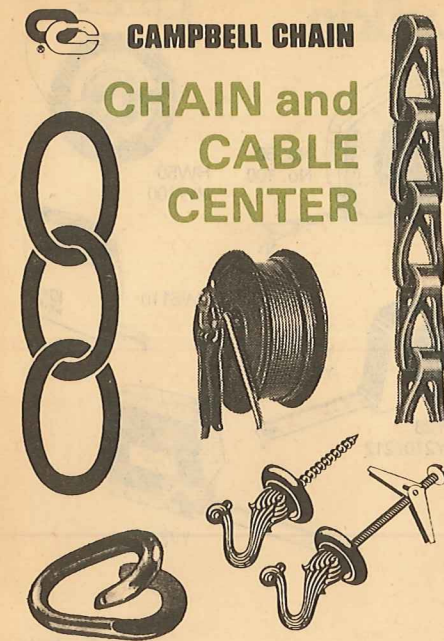

- CAMPBELL CHAIN**
- CHAIN and CABLE CENTER**
- Scotty's Price**
- 072-3027 2/0 Inco Chain B/K (ft.) 17c
 - 072-3227 #3 Inco Chain B/K (ft.) 14c
 - 072-3527 2/0 Machine Chain TW/LK/B/K (ft.) 61c
 - 072-3627 2/0 Coil Chain ST/LK/B/K (ft.) 42c
 - 072-3727 #35 Sash Chain B/K (ft.) 18c
 - 072-3817 1/0 Safety Chain (ft.) 32c
 - 072-4027 Jack Chain B/K (ft.) 11c
 - 072-5027 3/16 Proof Coil (ft.) 55c
 - 072-5127 1/4 Proof Coil (ft.) 87c
 - 072-5227 5/16 Proof Coil (ft.) 1.25
 - 072-5327 3/8 Proof Coil (ft.) 1.79
 - 595-0424 1/4 Clevis Grab Hook (1) 2.17
 - 595-0524 5/16 Clevis Grab Hook (1) 2.65
 - 595-0624 3/8 Clevis Grab Hook (1) 3.25
 - 490-0424 1/4 Cold Shuts (ea.) 35c
 - 490-0524 5/16 Cold Shuts (ea.) 37c
 - 490-0624 3/8 Cold Shuts (ea.) 47c
 - 580-0024 1/8 x 3/4 Repair Link (ea.) 9c
 - 595-0124 3/16 Repair Link (6) 85c
 - 595-0324 1/4 Repair Link (4) 95c
 - 595-0724 5/16 Repair Link (2) 75c
 - 595-0924 3/8 Repair Link (2) 90c
 - 400-0424 1/4 Grab Hook B/K (ea.) 80c
 - 400-0524 5/16 Grab Hook B/K (ea.) 1.25
 - 400-0624 3/8 Grab Hook B/K (ea.) 1.75
 - 605-2424 1/4 x 2 Welded Rings (ea.) 22c
 - 595-1124 #1020 Swivel and Snaps (2) 1.49
 - 595-3524 #34 Swivel and Snaps (2) 1.19
 - 595-4024 #40 S Hooks (card of 6) 52c
 - 595-6024 #60 S Hooks (card of 6) 72c
 - 595-8024 #80 S Hooks (card of 6) 98c
 - 072-0867 Brass Decorator Chain (ft.) 37c
 - 072-0897 Antique Brass Decorator Chain (ft.) 37c
 - 072-5847 Antique Copper Decorator Ch. (ft.) 37c
 - 700-3397 3/32 Cable (ft.) 14c
 - 700-3497 1/8 Cable (ft.) 23c
 - 700-0697 3/16 Cable (ft.) 40c
 - 700-0897 1/4 Cable (ft.) 61c
 - 595-0024 1/8 Cable Clip (card of 2) 79c
 - 595-0034 3/16 Cable Clip (2) 89c
 - 595-0044 1/4 Cable Clip (card of 2) 1.19
 - 541-0434 1/4 Screw Pin Anchor Shackle (ea.) 1.68
 - 541-0534 5/16 Screw Pin Anchor Shackle (ea.) 1.82
 - 541-0634 3/8 Screw Pin Anchor Shackle (ea.) 2.13

- ferum**
- ABD-712 Brass Swag Hooks (2) 1.15
 - ABD-712 Black Swag Hooks (2) 1.15
 - ABD-712 Antique Brass Swag Hooks (2) 1.15
 - ABD-712 Antique Copper Swag Hooks (2) 1.15

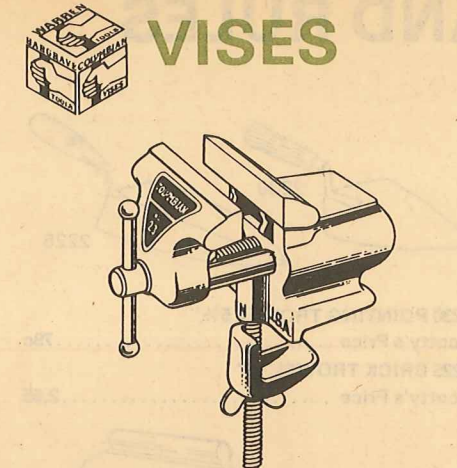

- 235 COLUMBIAN CLAMP VISE**
Ideal for home shop or serviceman. Fits bench, table or block up to 2 1/4" thick. Unbreakable 3/8" steel clamping stud. Fully-machined jaws. Smooth faces. Handy anvil. Gray and bright-plated finish.
- Scotty's Price 8.29

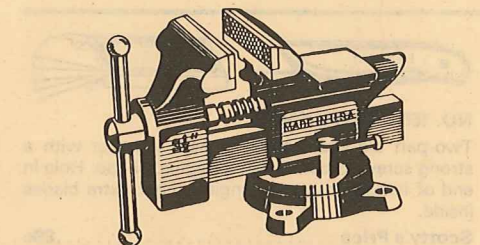

- 03 1/2 COLUMBIAN HOME SHOP**
3 1/2" jaw width, swivel base. Replaceable steel serrated jaw face. Built-in pipe jaws.
- Scotty's Price 12.49

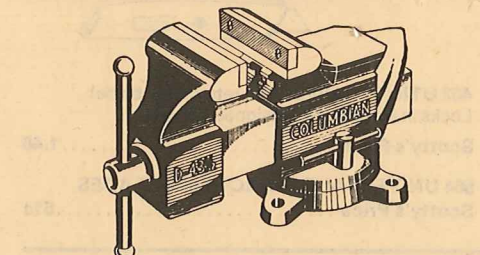

- D43 1/2 COLUMBIAN HOME SHOP**
Swivel base, hardened steel replaceable pipe jaws, serrated steel replaceable top jaw. Large anvil is polished, won't mar surfaces needlessly. Forming horn at rear is reinforced. Gray enamel finish.
- Scotty's Price 23.95

LUBRICANT

- WD-40**
- A clean, easy-to-use lubrication for sliding doors and windows, locks and hinges, lawn mowers or tools. Frees rusted parts and penetrates rust.
- 4D-12 11 oz. can 1.39

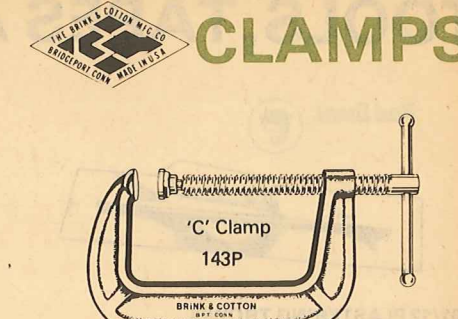

- CARRIAGE CLAMPS**
- 142P 2" Bright Nickel 87c
 - 143P 3" Bright Nickel 1.75
 - 144P 4" Bright Nickel 3.99
 - 146N 6" Natural 4.85
 - 148N 8" Natural 7.55

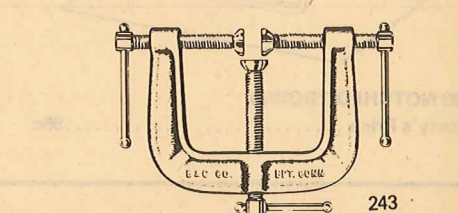

- EDGING CLAMP**
243 2 1/2" x 2" Bright Nickel 3.98

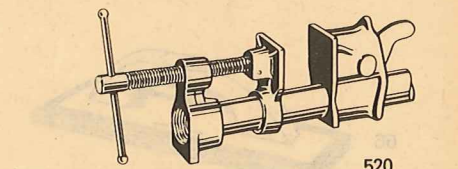

- CLAMP FIXTURE**
520 1/2" 4.99

RATCHET PULLERS (CABLE HOISTS)

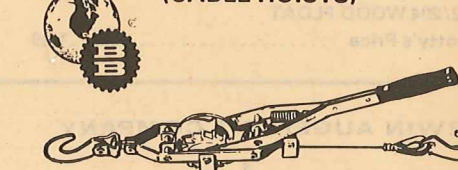

- RATCHET PULLERS** are designed for pulling loads horizontally and may be used for lifting and lowering. Steel parts, including frame, are cadmium plated. All models have 3/16" preformed galvanized aircraft cable.
- Q-14 Cable Hoist** has pulling capacity of one ton 12' with one line.
Scotty's Price 19.99
 - P-15D-3H Puller** has capacity of pulling one ton 15' with single line or two tons 6' with double line.
Scotty's Price 40.89