

# TOOLS FOR YOUR WORKSHOP

## MITRE BOXES

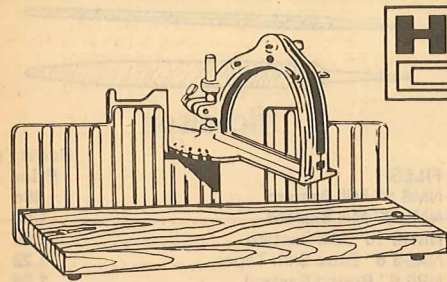

**Model 3619 MITRE BOX**  
Precision tool has aluminum saw guide assemblies, thumb screw-adjustments for saw blade width. All angles between 45° left or right can be made and held securely. Metal back with wood base. Saw not included.  
**Scotty's Price** .....10.99

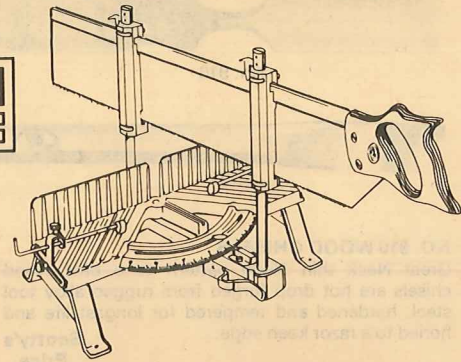

**Model 36281 PROFESSIONAL MITRE BOX**  
Saw guides can be adjusted to insure perfect vertical cuts, jaws ride on self-lubricating sintered bronze bearings for effortless cuts, adjustments are easily made. With 5' x 28", 11-point saw.  
**Scotty's Price** ..... 109.99\*



**NEW! 45° DURAL FACE MITRE**  
**HARD MAPLE MITRE BOX**  
No. 4516 - Size 16" x 5 1/2" x 2 3/4". One 90° mitre, two 45° mitres. Select rock maple (hardest wood). Kiln dried, will not warp. Precision cut, more accurate. Rabbeted and jointed to prevent misalignment.  
**Scotty's Price** .....2.19  
**4521 MITRE AND BACKSAW**  
**Scotty's Price** .....5.19

\*Not stocked at all stores — available at any store through the Winter Haven Warehouse.

## WOOD HANDLES

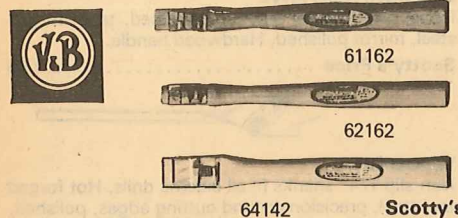

61162 14" Claw Hammer .....1.69  
62162 14" Machinist Hammer .....1.69  
64142 14" Hatchet Hammer .....1.89

### HARTWELL BROTHERS

**HANDLES**  
Single Bit Axe - 36" .....3.59  
Sledge - 36" .....3.49  
BRB 48" Shovel .....3.99  
RBF 5 Rake .....3.55

## SAWHORSES and BRACKETS

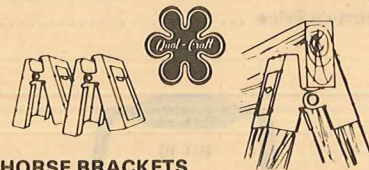

**SAWHORSE BRACKETS**  
A sturdy, durable sawhorse can be made of 5 pieces of lumber and these heavy gauge steel brackets. Per pair.  
**Scotty's Price** .....1.99

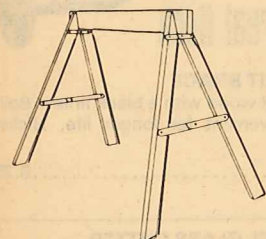

**FOLDING SAW HORSES 27" x 30" (Pair)**  
**Scotty's Price** .....9.99

## TOOL BOXES

### Kennedy Heavy Gauge "All-Steel"

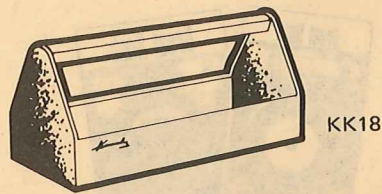

**KK18 ALL PURPOSE TOTE TRAY**  
Versatile all welded construction is 18 1/4" x 7 5/8" x 8 1/16". Ripple baked enamel finish.  
**Scotty's Price** .....5.89

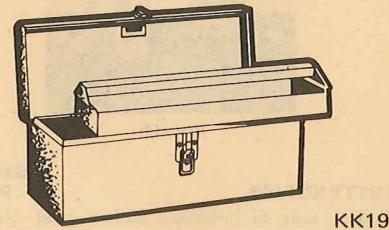

**KK19 TOOL BOX WITH TOTE TRAY**  
For home, farm, general or industrial use. Has ripple baked enamel finish. 19" x 7 1/8" x 7 3/4".  
**Scotty's Price** .....9.89

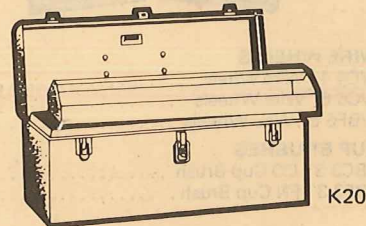

## WORK BENCH KIT

**WORK BENCH KIT**  
Constructed of durable, rugged yellow pine. Easy to assemble.  
**Scotty's Price** .....24.95

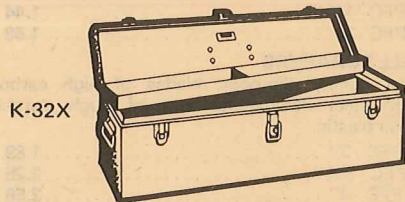
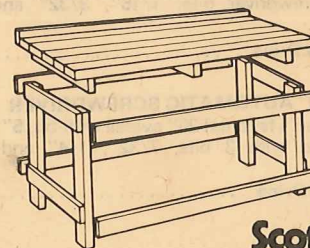

**K-32X GENERAL USAGE CARPENTER BOX**  
Has removable tray with two compartments, each 15 1/2" x 4 1/2" x 17/16". Space under tray measures 32" x 8 3/8" x 7 1/4".  
**Scotty's Price** .....24.99\*



\*Not stocked at all stores. Available at any store through Winter Haven Warehouse.

# HINGES and HARDWARE

## ferum PLASTIC PACKED HARDWARE



**2" UTILITY HINGES**  
RUST RESISTANT FINISH  
**3" T-HINGES**  
RUST RESISTANT FINISH  
**3" STRAP HINGES**  
RUST RESISTANT FINISH  
**1 1/2" CORNER BRACES**  
RUST RESISTANT FINISH  
**2 1/2" SAFETY HASP**  
RUST RESISTANT FINISH  
**3" FLAT CORNER IRONS**  
RUST RESISTANT FINISH

**BD-666 LIGHT NARROW BUTT HINGES**  
1 1/2" .....42c  
2" .....48c  
2 1/2" .....56c  
3" .....74c  
**BD-525 LIGHT "T" HINGES**  
3" .....68c  
4" .....82c  
**BD-526 LIGHT STRAP HINGES**  
3" .....60c  
4" .....82c  
**BD-226 CORNER BRACES**  
1 1/2" .....28c  
2" .....34c  
2 1/2" .....38c  
3" .....52c  
**BD-228 FLAT CORNER IRONS**  
2" .....28c  
3" .....36c  
**BD-246 SAFETY HASPS**  
2 1/2" .....44c  
3 1/2" .....56c  
4 1/2" .....69c  
6" .....99c

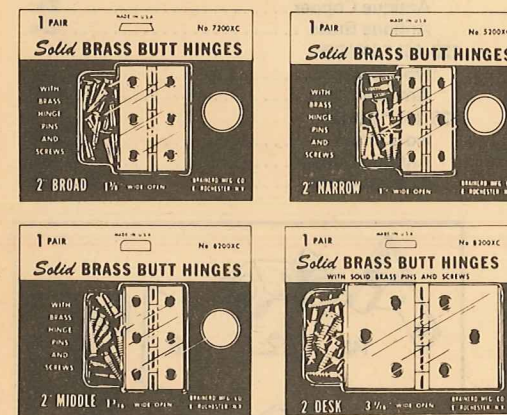

**SOLID BRASS BUTT HINGES**  
5075XC 3/4" Narrow .....72c  
5100XC 1" Narrow .....81c  
5105XC 1 1/2" Narrow .....72c  
5200 2" Narrow .....95c  
6075XC 3/4" Middle .....72c  
6100XC 1" Middle .....81c  
6150XC 1 1/2" Middle .....81c  
6200XC 2" Middle .....99c  
6250XC 2 1/2" Middle .....1.53  
7075XC 3/4" Broad .....81c  
7100XC 1" Broad .....90c  
7150XC 1 1/2" Broad .....90c  
7200XC 2" Broad .....1.08  
8150XC 1 1/2" Desk .....1.31  
8200XC 2" Desk .....1.89

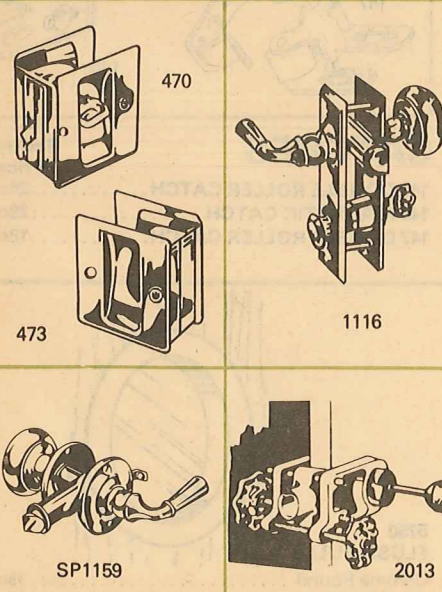

**DEXTER LOCKS**  
**SLIDING DOOR LOCKS**  
Passage Style  
473US28 Satin Anodized Aluminum .....3.99  
473 7A Antique Brass .....4.29  
473 28BR Brass Anodized Aluminum .....4.29  
Privacy Style  
470US28 Satin Anodized Aluminum .....5.95  
470 7A Antique Brass .....6.29  
470 28BR Brass Anodized Aluminum .....6.29  
**COLONIAL SCREEN DOOR LOCK**  
Reversible for any hand door from 7/8" to 1 1/8" thick. Satin Anodized Aluminum.  
SP1159 28 .....4.29  
**ALUMINUM SCREEN DOOR LOCK**  
Key lock has disc tumbler outside — turn knob inside. Satin Anodized Aluminum.  
1116 28 .....6.99  
**POWER INSTALLATION KIT**  
Power tool kit contains boring jig, strike locator, faceplate and strike mortise maker, 1 5/8" power bit, 15/16" power bit.  
2013-P Kit .....27.99

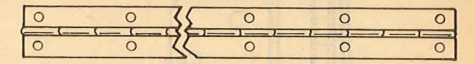

**30" STEEL CONTINUOUS HINGE**  
CD-1311US3 1 1/16" .....2.95  
CD-1311US3 1 1/2" .....3.25  
CD-1311US14 1 1/16" .....2.95  
CD-1311US14 1 1/2" .....3.25

**PRIME COAT BUTT HINGES**  
SC1741 3" x 3" Square Corner .....1.06  
SC1741 3 1/2" x 3 1/2" Square Corner .....1.06  
SC1741 4" x 4" Square Corner .....1.52

**AMERICAN-MADE HIGH QUALITY DOOR HINGES**  
Wrought steel. Loose pin butts with button tips. High quality finish. Sturdy hinge for exceptional value. Heavier gauge metal, full size knuckles, large steel pin. Trouble-free.

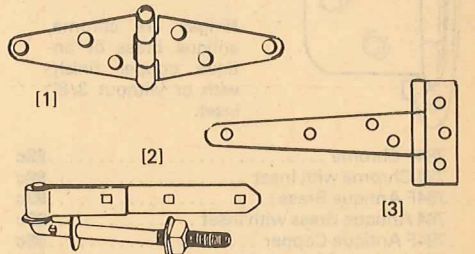

**[1] 1902 US2C ZINC HEAVY STRAP HINGES**  
Pair (without screws) .....1.92  
6" .....1.92  
8" .....3.25  
**[2] 1973 SCREW HOOK AND STRAP**  
(Gate Hinge)  
Per Pair .....4.35  
**[3] 1908 US2C ZINC EXTRA HEAVY T-HINGES**  
Pair (without screws) .....2.25  
6" .....2.25  
8" .....3.85

**1934 US2C ZINC GATE LATCH (with screws)**  
Each .....1.39

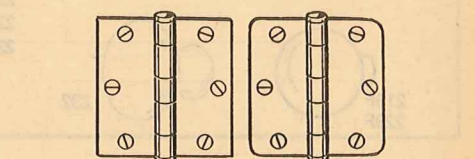

**LUMA SHEEN BUTT HINGES**  
1741 3" x 3" Square Corner .....1.31  
1741 3 1/2" x 3 1/2" Square Corner .....1.33  
1741 4" x 4" Square Corner .....1.89  
RC1741 3 1/2" x 3 1/2" Round Corner .....1.33  
RC1741 4" x 4" Round Corner .....1.89  
**BRASS BUTT HINGES**  
SC1741 3" x 3" Square Corner .....1.06  
SC1741 3 1/2" x 3 1/2" Square Corner .....1.06  
SC1741 4" x 4" Square Corner .....1.52  
RC1741 3 1/2" x 3 1/2" Round Corner .....1.06  
RC1741 4" x 4" Round Corner .....1.52

PRICES IN THIS CATALOG SUBJECT TO CHANGE WITHOUT NOTICE.