

Allison CABINET HARDWARE

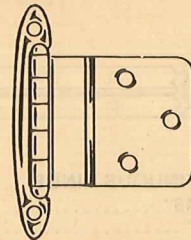

703
703F

703 SEMI-CONCEALED HINGE	Scotty's Price
Chrome59c
Antique Copper59c
703F HINGE	
Chrome59c
Antique Copper59c
Antique Brass59c
Satin Pewter59c

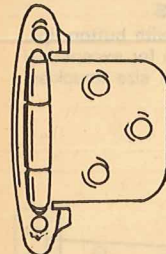

SELF-CLOSING HINGES

Hinges are chrome, antique brass or antique copper finish, with or without 3/8" inset.

784F Chrome99c
784 Chrome with Inset99c
784F Antique Brass99c
784 Antique Brass with Inset99c
784F Antique Copper99c
784 Antique Copper with Inset99c

HINGES, KNOBS and PULLS

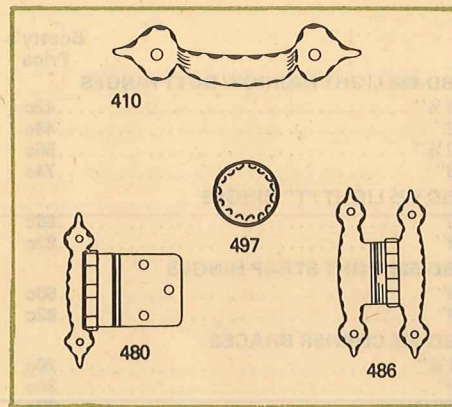

Colonial

410 PULL	Scotty's Price
Black26c
Antique Copper26c
497 1 1/16" KNOB	
Black26c
Antique Copper26c
486 H-HINGE	
Black79c
Antique Copper79c
480 SEMI-CONCEALED HINGE	
Black79c
Antique Copper79c

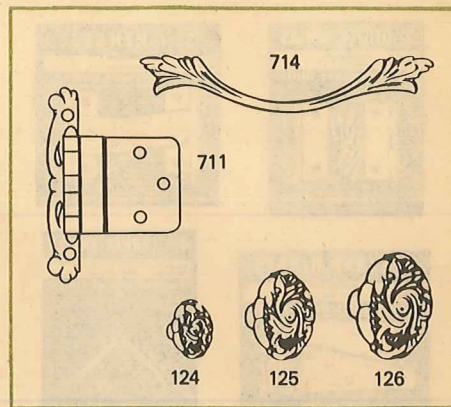

Provincial

714 3" PULL	Scotty's Price
Antique Brass35c
Antique Copper35c
Ivory Brass35c
711 SEMI-CONCEALED HINGE	
Antique Brass79c
Ivory Brass79c
124 1" KNOB	
Ivory Brass24c
Antique Copper23c
Antique Brass23c
125 1 1/4" KNOB	
Ivory Brass27c
Antique Brass27c
126 1 1/2" KNOB	
Ivory Brass36c
Antique Copper36c
Antique Brass36c

CERAMIC KNOBS

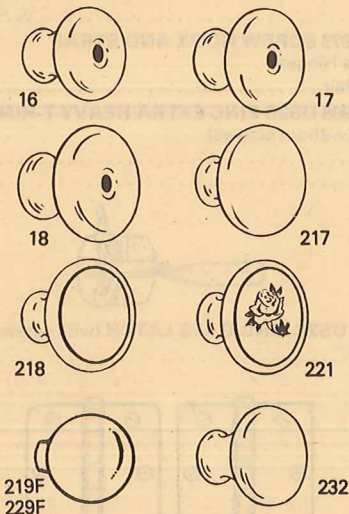

16 1" KNOB - White	Scotty's Price
.....	.35c
17 1 3/16" KNOB - White39c
18 1 1/2" KNOB - White45c
217 1 1/2" KNOB - White, Blue, Orange, Red, Yellow65c
218 1 1/2" KNOB - White79c
219F 1 1/4" KNOB - White, Blue, Orange, Red, Yellow, Black79c
221 1 1/2" KNOB - White79c
229F 1" KNOB - White66c
232 1 1/4" KNOB - White59c

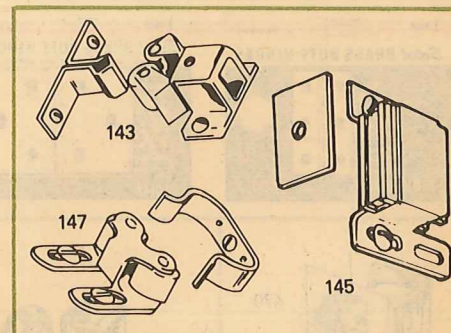

CATCHES

143 DOUBLE ROLLER CATCH	Scotty's Price
.....	.26c
145 MAGNETIC CATCH28c
147 DOUBLE ROLLER CATCH18c

SOLAR DRAWER SLIDE

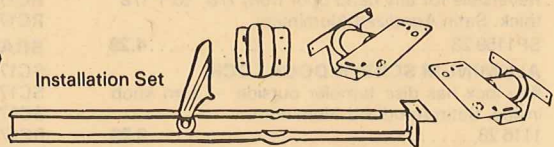
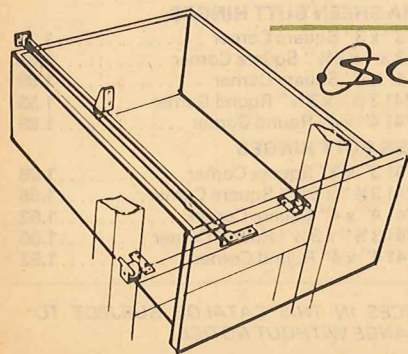

7100 DRAWER SLIDE	
Contains 1 rear guide wheel, 2 nylon wheels and rear mounting socket.	
Set99c

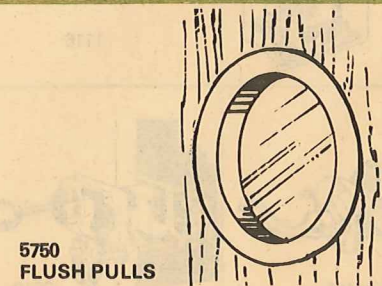

5750 FLUSH PULLS	
Chrome Round19c
Brass Round19c

HAND TOOLS

Great Neck



LK-25C

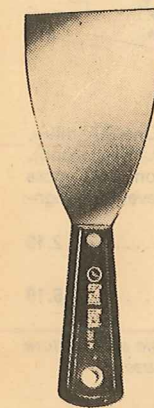

Wall Scraper

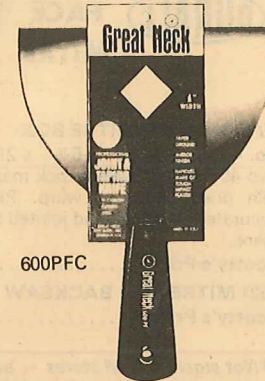

600PFC



VF-105

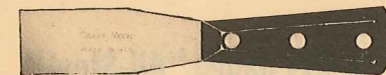

125PFC



VP-105

PUTTY KNIVES

Blades made of hi-carbon cutlery steel. Handles made of tough, impact plastic.

125PFC - 1 1/4"	1.44
200PFC - 2"	1.69

WALL SCRAPERS

Finest quality clip-point blades of high carbon cutlery steel with handles made of tough, durable impact plastic.

300 PFC - 3"	1.89
350PFC - 3 1/2"	2.25
400 PFC - 4"	2.59

600PFC JOINT AND TAPING KNIFE

Made of top quality materials. High impact black plastic handle. 6" blade.

Scotty's Price2.99

LK-25C LINOLEUM KNIFE

A professional quality tool for the mechanic or home craftsman. Tapered tool steel blade is chrome plated, ferrule is nickel plated.

Scotty's Price1.45

VF-105 VERSAFILE

This tool provides edge-to-edge filing over a 10 sq. in. surface. Gives a good, clean finish with minimum pressure and files faster than a conventional file.

Scotty's Price4.99

VP-105 VERSAPLANE

A comfortable dual-purpose tool. Handles like a conventional plane, produces best results with minimum pressure. Amber plastic handle.

Scotty's Price6.29

GREAT NECK WOOD RASP

SW10C 10" 1/2-Round Wood

2.99



125 GRINDING WHEELS	
Assorted Sizes (each)69c



No. 910

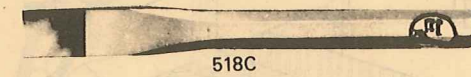

518C

NO. 910 WOOD CHISELS

Great Neck thin blade pattern tang butt wood chisels are hot drop forged from rugged alloy tool steel, hardened and tempered for longest life and honed to a razor keen edge.

	Scotty's Price
1/4"	2.45
3/8"	2.49
1/2"	2.55
5/8"	2.59
3/4"	2.65
1"	2.85
1 1/4"	3.35
1 1/2"	3.59

518C 7" COLD CHISEL

Full hand polished on face and head to a magnificent finish, and scientifically hardened and tempered. 3/4" cutting edge.

Scotty's Price2.35



WIRE WHEELS

WC4 4" Wire Wheel	1.54
WC6 6" Wire Wheels	2.39
WBF6 6" Wire Wheels	2.39

CUP BRUSHES

CBC3 3" CO Cup Brush	2.19
CBF3 3" FN Cup Brush	2.19



97AC

97AC 10" RATCHET SCREWDRIVER

Really handy! 10" overall length. Five different bits stored in hollow clear plastic handle. 3/16" and 1/4" screwdriver bits: 1/16", 3/32" and 1/8" drill bits.

Scotty's Price6.09

277-A 20" AUTOMATIC SCREWDRIVER

Craftsman's favorite! 20" overall with bit, 5" stroke. Furnished with 3 bits, 7/32", 1/4" and 9/32" drivers.

Scotty's Price12.79



W-3

277-A

W-3 SCREWDRIVER BIT KIT

Two bits for slotted screws, 5/32" and 1/4".

Scotty's Price89c

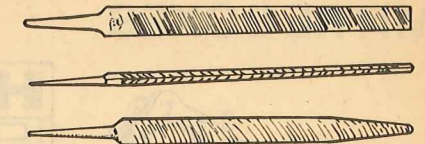

Nicholson

FILES

NM6 6" Mill Bastard99c
NM8 8" Mill Bastard	1.59
NM10 10" Mill Bastard	2.09
NXS6 6" Extra Slim Taper	1.29
NR6 6" Round Bastard	1.59
NR8 8" Round Bastard	1.89

No. 2 FILE HANDLE

Scotty's Price79c

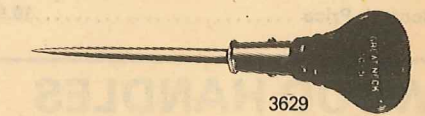

3629

3629 SCRATCH AWL

Finest professional quality! Hardened, taper-forged steel, mirror polished. Hardwood handle.

Scotty's Price1.95



WOOD BITS

Non-slip 1/4" shanks fit all electric drills. Hot forged tool steel, precision ground cutting edges, polished, rust resistant finish.

2106 3/8"	1.00
2110 5/8"	1.15
2114 7/8"	1.29

IRWIN AUGER BIT CO.

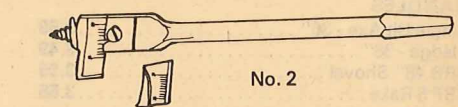

No. 2

No. 2 EXPANSION BIT

Adjustable 2-piece expansive bit; drop-forged alloy tool steel. Fits 1/4" and larger drills, cuts holes in wood or plastic. 7/8" to 1 1/4" and 1 1/4" to 3".

Scotty's Price6.99

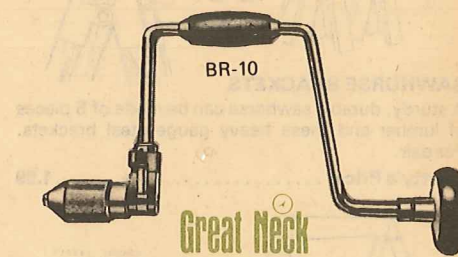

BR-10

BR-10 RATCHET BIT BRACE

Handles are chestnut wood with a black finish. Ball-bearing handle movement for longer life. Nickel plated parts.

Scotty's Price6.75

1063R RED DEVIL GLASS CUTTER

Scotty's Price1.12